

NEW!



**CGLASS LOFT**  
LOFT STYLE GLASS DOORS

**CGLASS**<sup>®</sup>  
GLASS FITTINGS

# 2023

CGLASS LOFT

**CGLASS**<sup>®</sup>  
GLASS FITTINGS

**NORGPOL** Czerwiński Sp.J.

**Head Office**  
02-867 Warsaw  
Baletowa 104  
Poland

**Logistic Centre**  
08-500 Ryki  
Przemysłowa 4  
Poland

biuro@cglass.pl  
export@cglass.pl  
+48 22 33 15 400



[www.cglass.eu](http://www.cglass.eu)

**FOLLOW US ON**



# CGLASS LOFT

## LOFT STYLE GLASS DOORS

### ALUMINIUM DOOR FRAMES



OFC-1-100-130



OFC-1-130-160



OFC-1-160-195



OFC-2



OFC-3



OFC-45

**NEW!**

# CGLASS LOFT

## LOFT STYLE GLASS DOORS

### HINGE FOR LOFT DOOR

NTZ-650

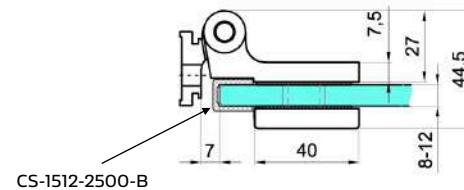
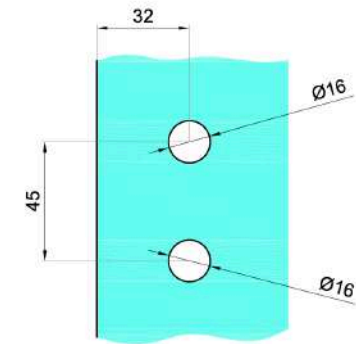
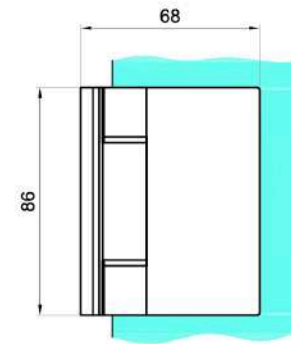
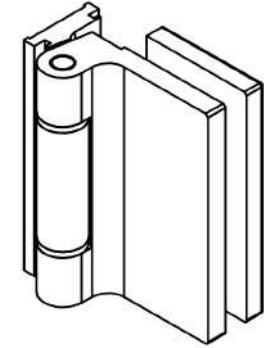

CS-1512-2500-B

**ATTENTION!** Glass cut out is different as for NTZ-500 / NTZ-600 / NTZ-1000

**CONNECTION OF CS-1512-2500-B PROFILE WITH NTZ-650-B HINGE DOES NOT REQUIRE PROFILE CUTTING.** THE PROFILE IS SLIED ENTIRELY ON THE EDGE OF THE MOUNTED GLASS DOOR.

# CGLASS LOFT LOFT STYLE GLASS DOORS

**NEW !**

# CGLASS LOFT LOFT STYLE GLASS DOORS

## STANDARD FRAME PROFILE



CS-1512-2500-B

## FRAME PROFILE WITH MILLING FOR DOOR LOCK

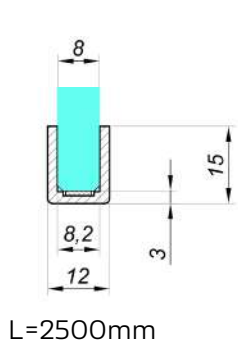

L=2500mm

Milling on the height 1100mm

CS-1512-2500-F-L-B - drzwi lewe  
CS-1512-2500-F-R-B - drzwi prawe

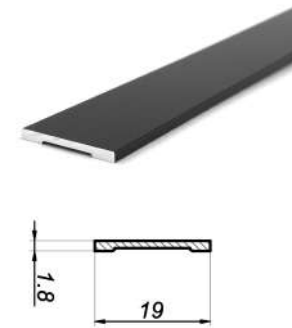
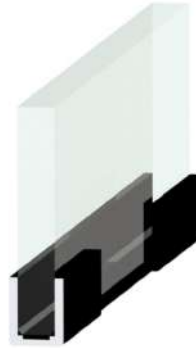

CS-1902-3000-B  
GRID PROFILE

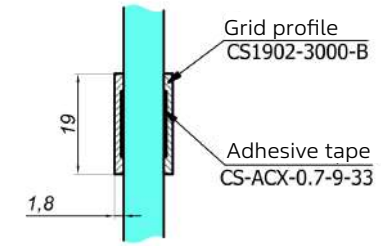

CS-ACX-0.7-9-33  
ADHESIVE TAPE

## ACCESSORIES



## DOOR HANDLES



G800-450-B  
L=450mm

NLO-ZD-2857-610-B  
L=635mm

NLO-ZD-2857-457-B  
L=480mm

NLO-ZD-2856-B  
L=230mm

NLO-ZD-2816-B  
L=170mm

# CGLASS LOFT MAGNET

LOFT STYLE GLASS DOORS  
WITH MAGNET HIDDEN LOCK



NEW!

# CGLASS LOFT MAGNET

LOFT STYLE GLASS DOORS  
WITH MAGNET HIDDEN LOCK

## SET OF MAGNET CLOSING

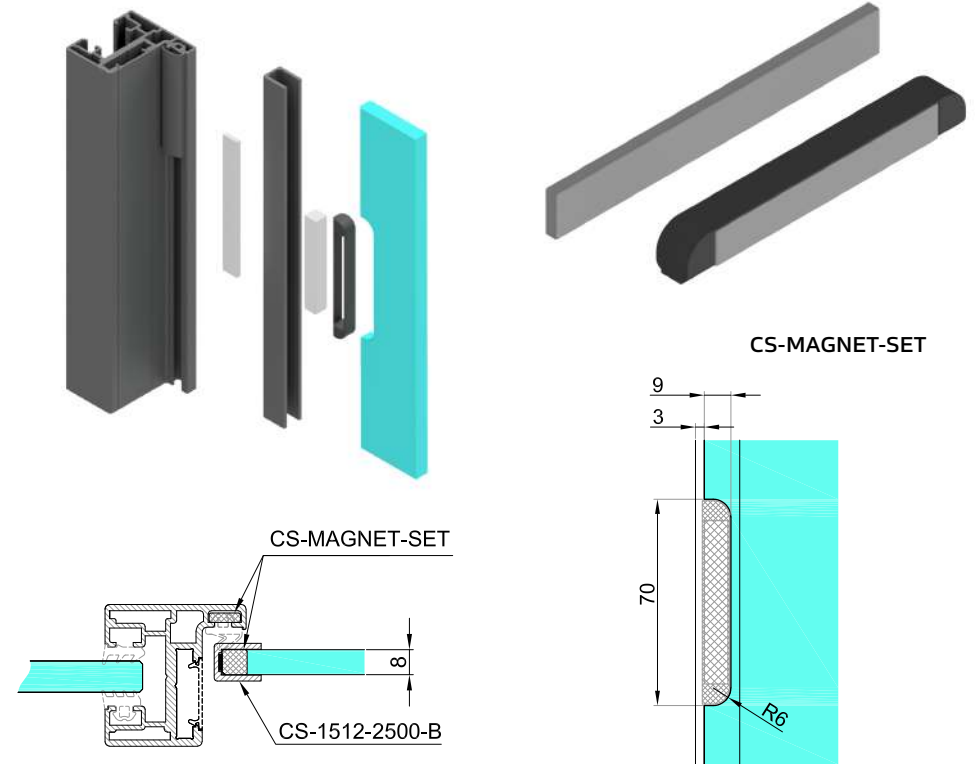

APPLICATION EXAMPLE

GLASS PREPARATION

### INSTALLATION

FLAT MAGNET SLIDE INTO THE FRAME. THE SECOND MAGNET IS INSTALLED IN THE PLACE OF THE CUT IN THE GLASS BEFORE APPLYING THE U SHAPE PROFILE ON THE GLASS.

**AFTER ASSEMBLY, THE CLOSING MECHANISM IS INVISIBLE!**